

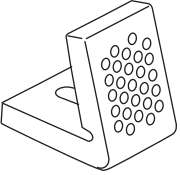

PARTS SUPPLIED:

Check to make sure that all these parts are included in the package:

 <p>L bracket 2x</p>	 <p>Hex head screw 2x</p>	 <p>Wall plug 2x</p>	
 <p>Screw 2x</p>	 <p>Washer 2x</p>	 <p>Chrome cap 2x</p>	

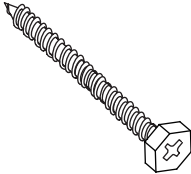
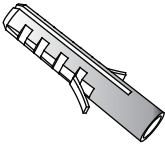
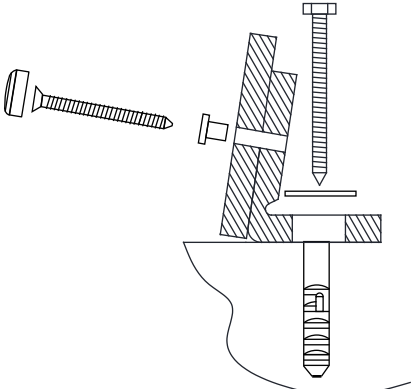
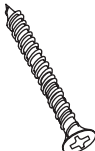

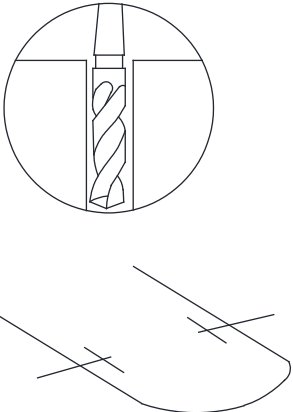
1. Place the product into position and mark the location of the fixing holes required.
 2. Remove the product and drill 10mm holes using a suitable drill bit.

3. Secure the L bracket using the side with the single hole and tighten to the wall/floor.

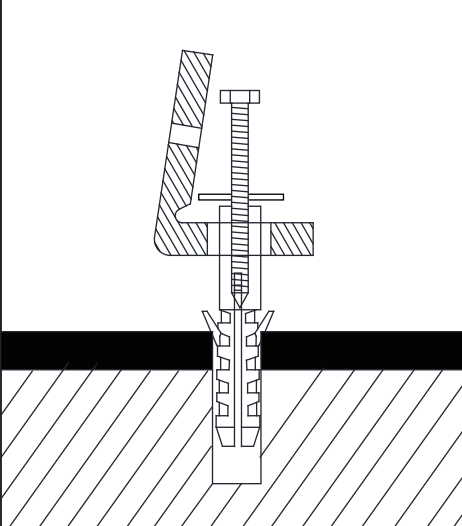
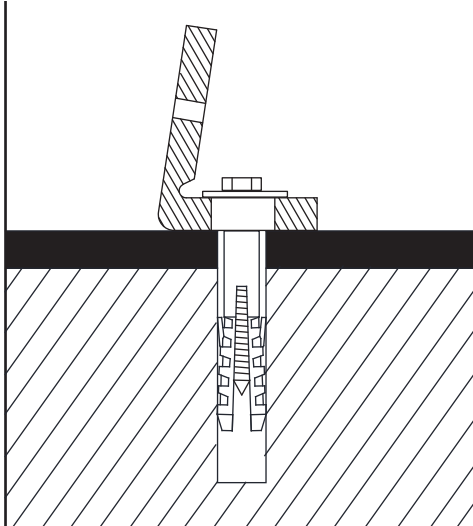
4. Re-locate the product.

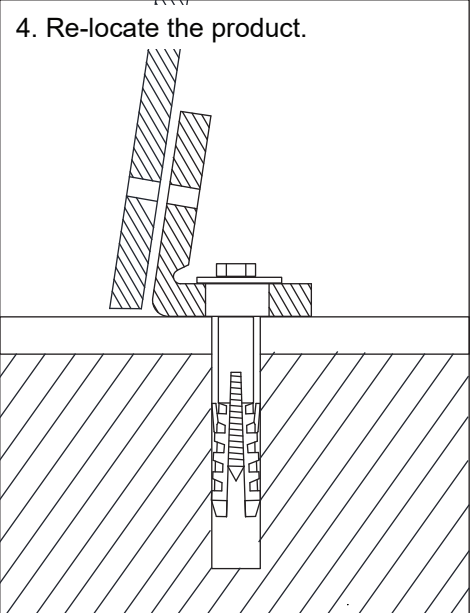

5. Secure into the L bracket, ensure the grommet for the screw cap is fitted to the screw before fitting and once tight connect the cover cap to finish.

