



**REARO**   
COMMERCIAL SURFACES

**GENERAL INSTALLATION GUIDE**  
CUBICLES, VANITY UNITS AND IPS

# Washroom Cubicle Fitting Instructions



## Step 1 MEASURING UP

Measure and mark off a vertical line on the back wall for the positions of the partitions. Then mark on the wall the positions to fix the 3 brackets.

## Step 2 FITTING BRACKETS

Fix 3-No channel brackets as required for each partition on the vertical line drawn on the wall. Brackets should be fitted 80mm from top & bottom of partition and 1-No bracket in the centre of the partition.

## Step 3 FITTING PARTITION SUPPORT

Attach the support leg to the partition 100mm from the front edge and adjust to the correct height. Ensure the partition is aligned correctly and fix the support to floor.

## Step 4 FITTING PARTITIONS

Ensure the partition is level and fix brackets to the partition using the T-nuts provided.

## Step 5 FITTING FASCIA (PILASTERS)

Mark off the positions of the 3-No brackets on the fascia. Fix the channel brackets to the fascias 80mm from top & bottom of fascia with 1-No bracket in the middle of the fascia, then fix the fascia to the partition with T-nuts provided. Imperial & Mercury Cubicles use 'L' brackets at the end fascias.

## Step 6 FITTING HEADRAIL

With the partitions and fascias permanently fixed, the headrail must be cut to length, fitting end cap if required, then placed in position over the tops of the fascia's bridging the door gap. Fix the headrail permanently by attaching to the top of the fascias.

## Step 7 FITTING THE DOOR, HINGES AND LOCK ASSEMBLY.

Attach the hinges to the fascias and door, all as per specified cubicle system, ensuring the door is hung horizontal and level. Then attach the indicator bolt to the door as per specified fitting instructions. Engage the lock and mark off on the fascia the point to attach the keep. Unlock the indicator bolt and attached the keep using the fixings provided.

Each of Rearo Laminates toilet cubicle system has specific / bespoke fitting instructions (supplied separately)

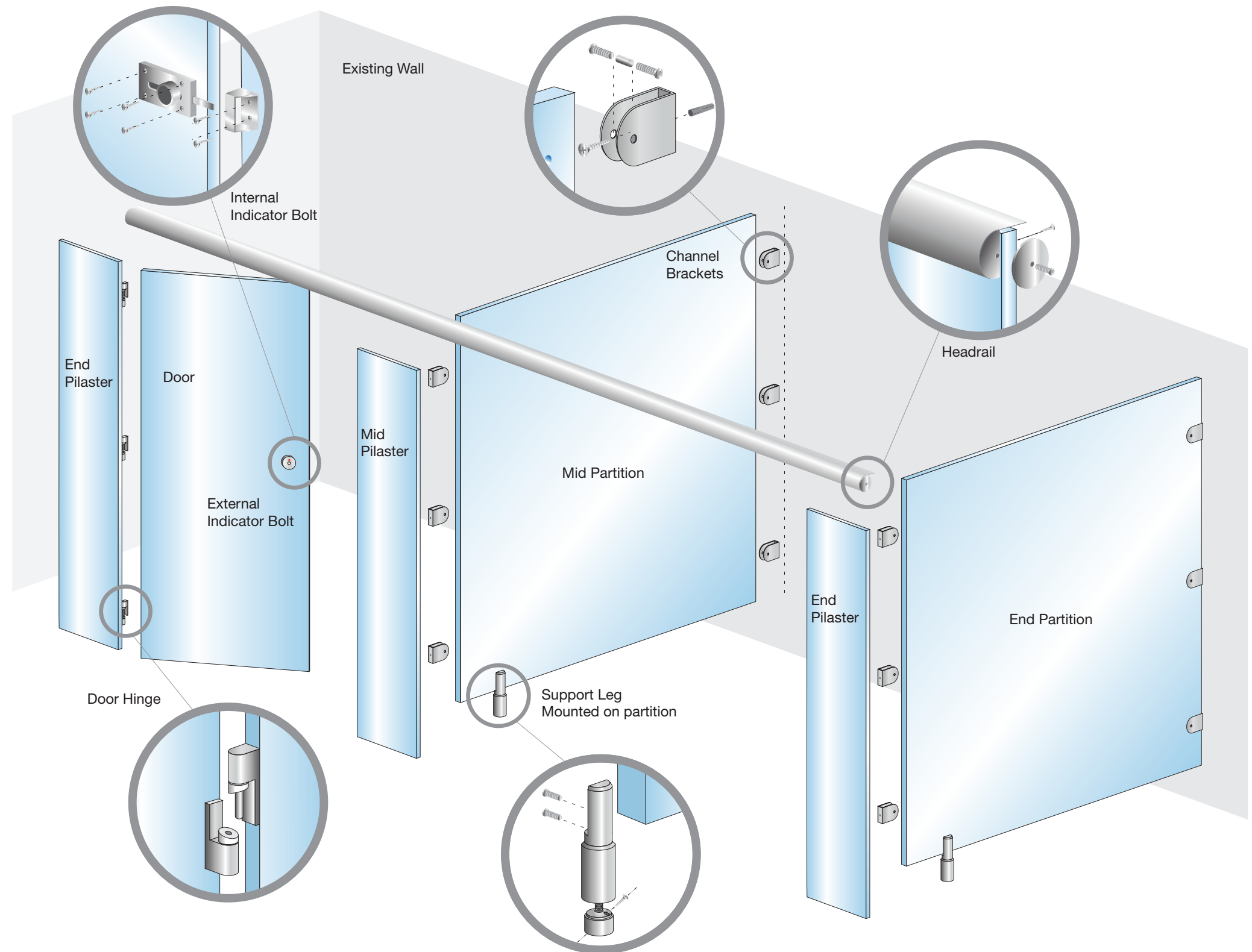

## VANITY UNIT INSTALLATION

RapidFit vanity units are designed to be as versatile as possible, to allow standard components to be used in all types of room arrangements.

It is assumed that all timber framing is provided by the installer and constructed to suit the on site dimensions. Treated timber should be used for the first fix and any cut outs made to the supplied panels, that would be exposed to moisture, must be suitably sealed. Sanitaryware and plumbing items are not supplied with these units.

Construct timber framing to suit the required Vanity Unit dimensions **A**. Please ensure framing is built to a sufficient height to allow for skirting (normally 100mm) and Access Panels plus an additional 20mm above the Access Panel to allow clearance for the Gravity Fixing Clips. A suggested overall framing height of 780mm is recommended. If Vanity Unit is corner sited, the framing needs to be left 40mm short of Vanity Top - see Optional\* Decor End Panel instruction (page 2).

Framing for the Shadow Gap should be set back 60mm from the depth of the Vanity Top to ensure that, when the Access Panels are installed, any excess water dripping off the downstand will drop onto the floor and not onto the Access Panel **F**.

Shadow Gap material is supplied as three 150 x 2800 x 18mm lengths. This material should be cut on site to the required site dimensions and screwed to all inner edges to the timber framing, to ensure all fixings are hidden behind Access Panels (as per diagram **B**).

Access Panel(s) are fixed by means of Lift-on Lift-off plastic Gravity Clips, the location of these clips on the panels and Shadow Gap will ultimately be determined by overall site dimensions. However, the Access Panel is manufactured 100mm shorter in length than the Vanity Top, to leave a suggested vertical Shadow Gap of 50mm (as per diagram **C**).

Fix the Vanity Top to the framing by screwing through the framing on to the underneath of the top. Please remember the top is 20mm thick, be careful to avoid screws breaking through the top surface. (as per diagram **E**).

### FITTING BETWEEN WALLS

For fitting Decor End Gable Panel or Semi Recessed Sinks - see page 2

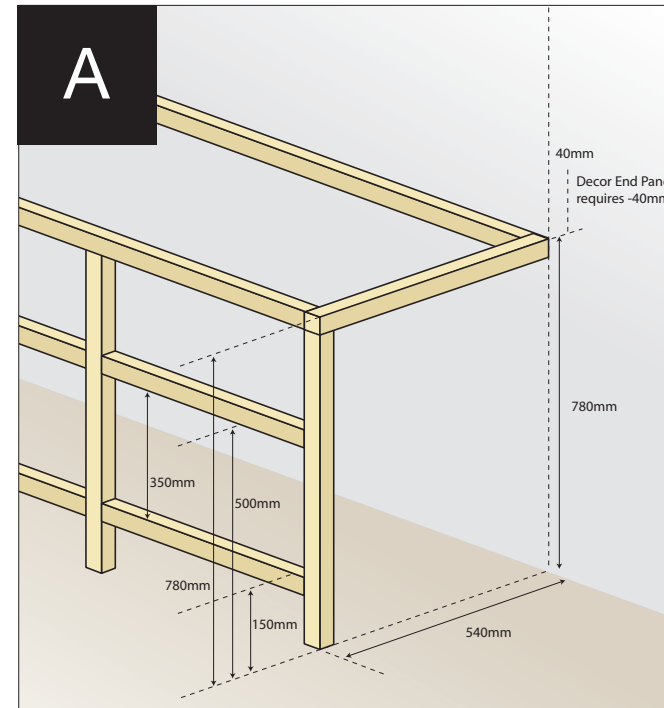

**FRAME**

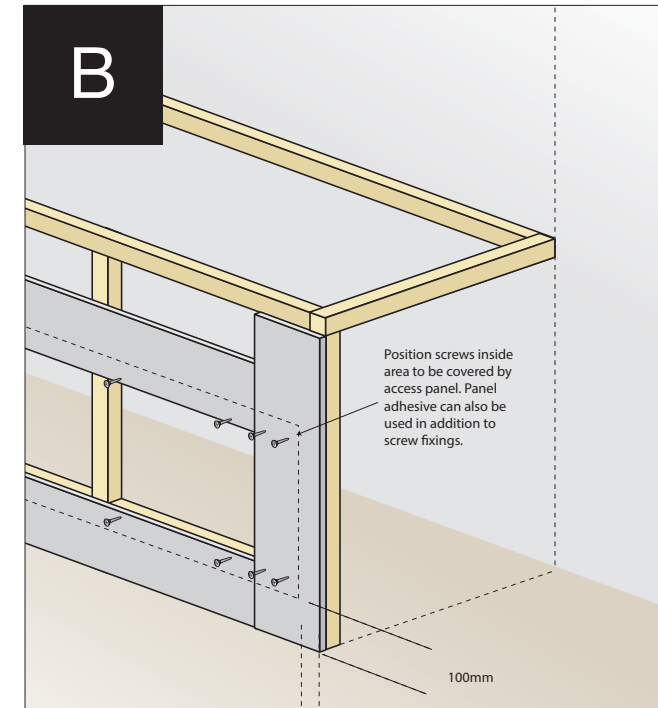

**SHADOW GAP**

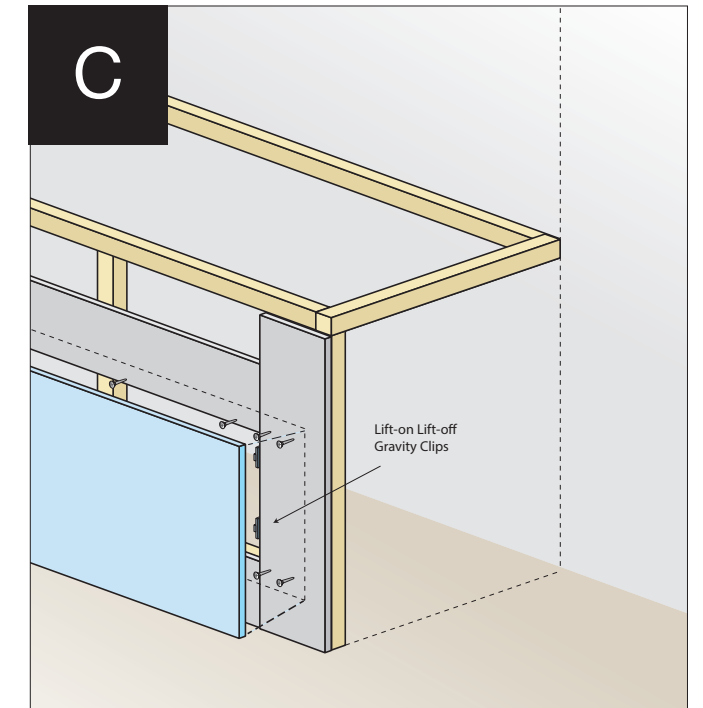

**ACCESS PANEL**

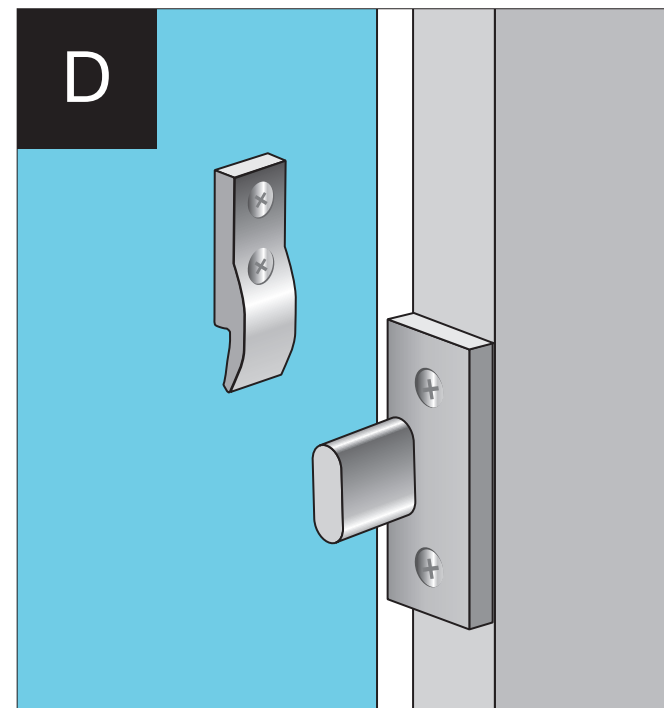

**LIFT-ON LIFT-OFF GRAVITY CLIPS**

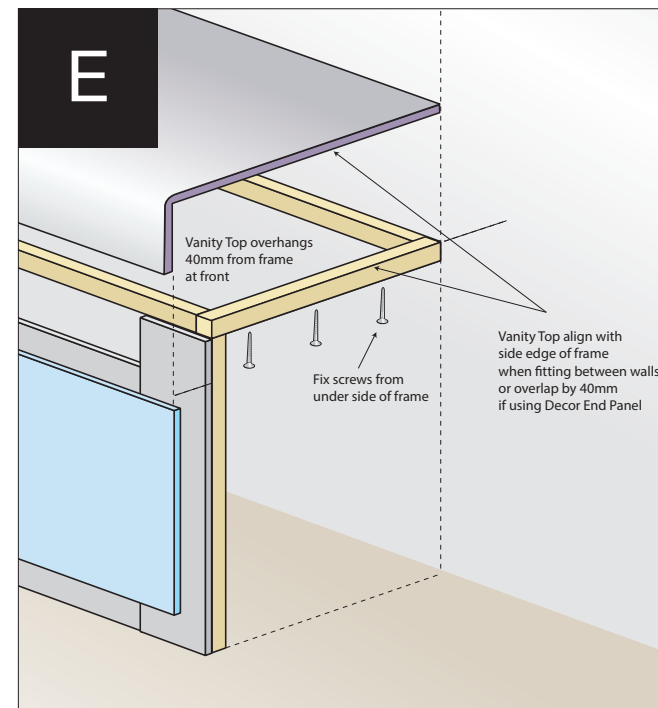

**VANITY TOP**

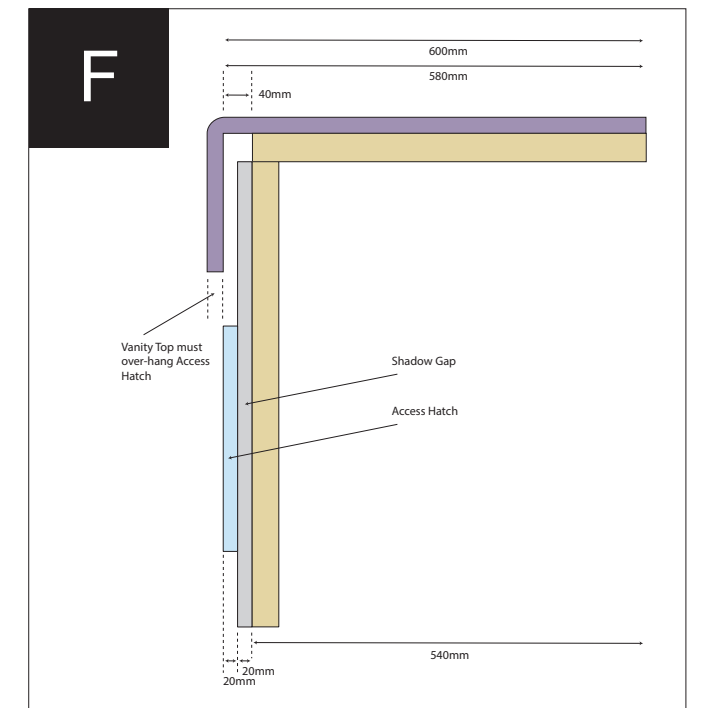

Illustrations not to scale



## FITTING CORNER SITED UNITS

### OPTIONAL\* DECOR END PANEL

An additional pack is available for corner-sited arrangements. In such a circumstance, the framing should be left 40mm short of the overall vanity length, and the Shadow Gap side edge should project 18mm past the frame. This is to allow the Decor End Gable Panel to master (tuck in behind) the Shadow Gap.

Larger Gable Panel is supplied at 560mm deep to allow scribe to wall. The panel should then be fixed by screwing from the inside, if accessible, alternatively glue on the panel. If screws need to be used from the outside, position above 600mm to avoid the screw heads showing (as per diagram **G**).

The small 580 x 180 x 18mm MDF return panel is then glued to the underside of the Vanity Top (as per diagram **H**).

The loose laminate is then glued (contact adhesive) to the exposed blocked end and should be trimmed around the top and downstand to leave an attractive neat finish (as per diagram **I**).

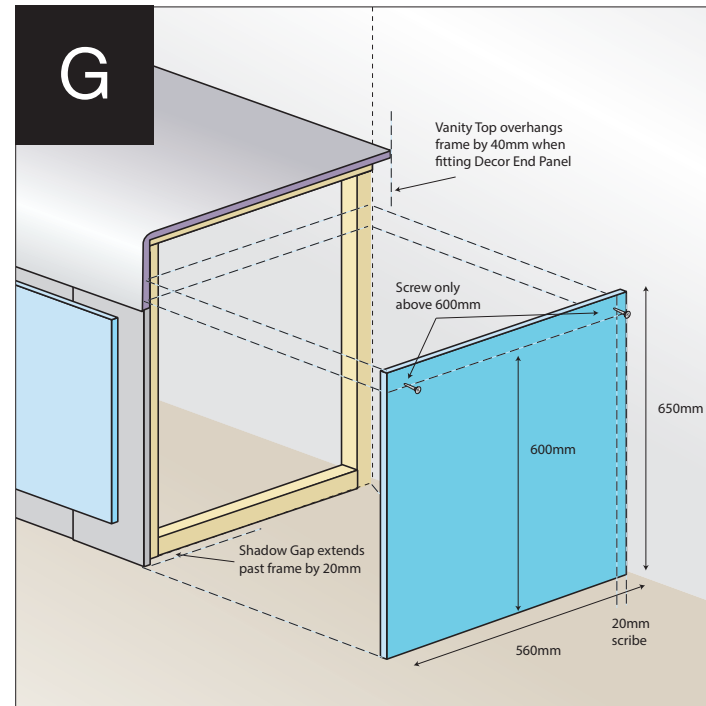

**DECOR END GABLE PANEL**

- Complete the End Frame
- Top frame less 40mm to allow vanity top overhang
- Panel supplied 560mm wide to allow for scribe to wall, should be fixed flush to front covering Shadow Gap edge.
- Alternatively the Shadow Gap can be fitted projecting 18mm past the end frame to allow the Décor End Gable Panel to master behind the Shadow Gap. The exposed core of the Shadow Gap can then be covered by gluing on the additional PVC edging strip supplied with the Décor End Kit.



Panels are all manufactured from 18mm Moisture Resistant Melamine Faced Chipboard (MR-MFC) and all visible edges are edged with a 2.0mm colour matched PVC. The Vanity Top is manufactured from Moisture Resistant MDF faced with High Pressure Laminate. It is essential that when site dimensions require panels to be cut down on site that any edges, which may be exposed to moisture, are sealed with a suitable sealant. Similarly, all basin and plumbing holes and cut outs should be sealed to avoid prolonged contact of the core to moisture.

### Care and Maintenance:

All panels should be cleaned with a damp cloth and non-abrasive mild detergents.

*Please note: panels are manufactured for use in commercial washrooms. However, they are not designed for prolonged contact with water. Panels should not be submerged in or be exposed to long term contact with water. Rapidfit panels should not be used in shower, sauna or steam rooms.*

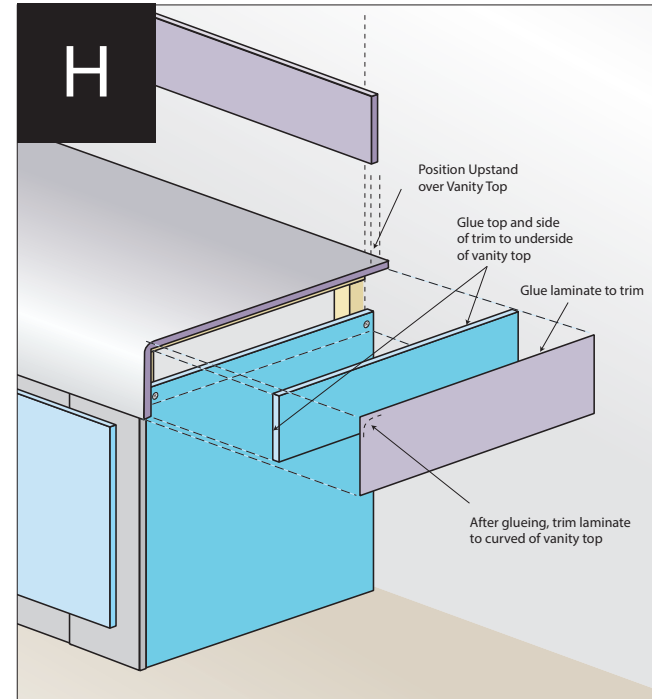

**DECOR END VANITY PANEL, LAMINATE & UPSTAND**

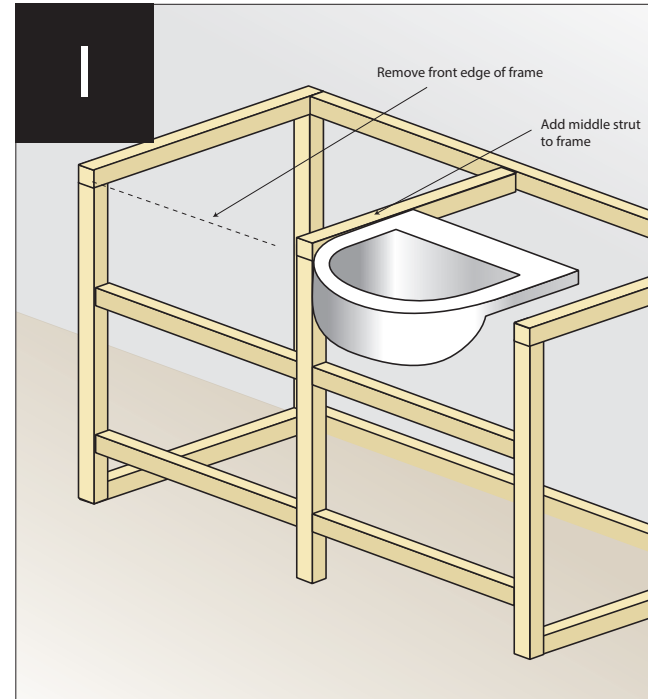

**POSSIBLE FRAMING WHEN USING SEMI-RECESSED SINKS**

# IPS INSTALLATION GUIDE

Prior to beginning your project, please check all materials are as per order and check drawings to suit required layout. If there are any discrepancies, please contact Rearo's Commercial Department to discuss (0141-440-0800).

## PREPARATION

Assess area for installation of IPS, noting any gradient on the floor or walls, allowing this to be considered during installation

Using a spirit level, align and mark the required position of the timber frame.

## STEP 1: FRAMING



Fig 1

- Cut and install perimeter timber frame to the required layout. Additional vertical timbers may be required where multiple runs of IPS are situated side by side. Please refer to Rearo's project specific IPS layouts where applicable.

## STEP 2: APPLICATION OF SHADOW GAP

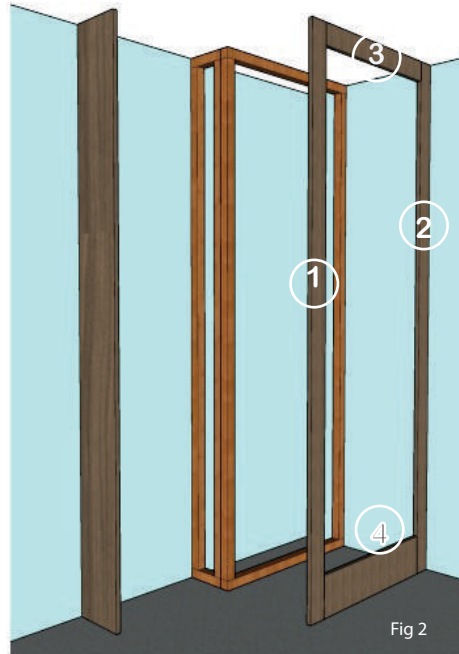

Fig 2

- Install two outer shadow gaps [1&2] first, ensuring they are plumb and level. If IPS has a return end remember to extend face shadow gap by 20mm past the framework. This will ensure no visible join to the face of the panel. Refer to figure 2.1
- Install sections 3 and 4 ensuring they are square and level
- Please note, when installing all s/gap strips, fix the strips to the inside edge of the area. This way the fixings will be hidden once the IPS panels are fitted.
- Install further mid s/gaps if required
- We recommend additional timbers where cubicle partitions meet the framing. Refer to figure 2.2

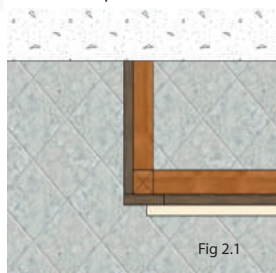

Fig 2.1



Fig 2.2

## STEP 3: INSTALLATION OF IPS

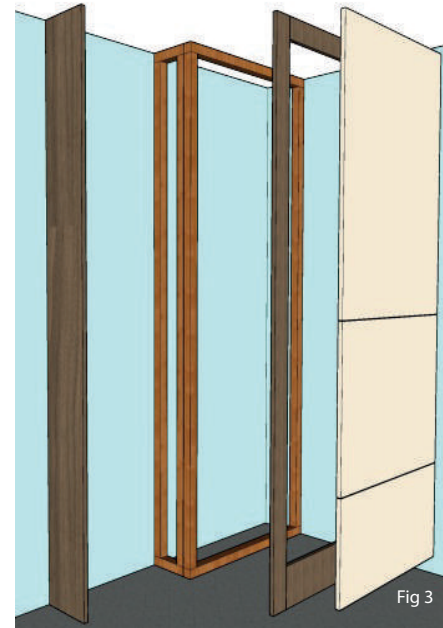

Fig 3

Fit part A of ke ku clips to inner edges of shadow gaps, align the bottom IPS panels in correct position ensuring it is level and mark the reverse to allow part b of the ke ku clips to be fitted. Screw and fit clips. Clip on the panel and ensure that it is level, adjust if necessary. See figure 3.1

Repeat above two processes until all IPS panels are installed

When installing compact grade IPS panels, please note the different type of screw fixings within the ke ku clip bags. This is to ensure the screw doesn't burst the face. For Compact grade ensure the M4x13mm Tatptie machine screws are used. MFC panels will require the wood screws provided.

## STEP 4: COMPLETION

Remove protective film from panels and shadow gap and to finish clean as per standard instruction (O&M)

### Tools required:

- Screw Gun/ drill
- Hand saw
- IPS panels
- Shadow Gap lengths
- Lift on/ off clips (pack of 4 per panel)
- Push on/ off clips (if required)
- S/wood Timber
- Spirit Level/ Laser Measure
- Tape Measure
- Suction Handle
- PPE (if required)

Fig 3.1

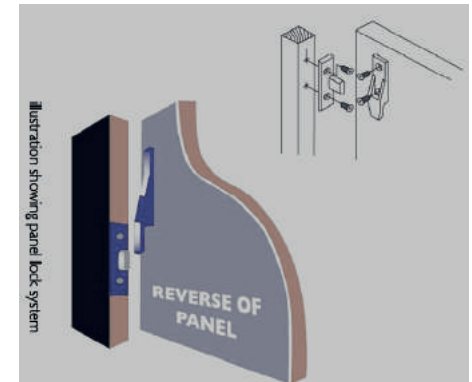

Illustration showing panel lock system

Keku clip detail



FURTHER INFORMATION

For more information regarding Buhne or to book an appointment with Business Development Manager, Robert Bennett, please contact: E: [robert.bennett@rearo.co.uk](mailto:robert.bennett@rearo.co.uk) or alternatively M: 07919015647



Rearo, Loanbank House, Loanbank Quadrant, Govan, Glasgow, G51 3HZ  
Tel: 0141 440 0800 Fax: 0141 445 3342 [www.rearo.co.uk](http://www.rearo.co.uk) [sales@rearo.co.uk](mailto:sales@rearo.co.uk)